

SPECIFICATIONS:

CONTACT RATING: Refer to "Contact Material Options".
 ELECTRICAL LIFE: 30,000 make-and-break cycles at full load.
 CONTACT RESISTANCE: 20mΩ max. initial @2-4VDC, 100mA
 INSULATION RESISTANCE: 1,000mΩ min.
 DIELECTRIC STRENGTH: 1,500V RMS min.@sea level.
 OPERATING TEMPERATURE: -30°C to +85°C.

MATERIALS:

CASE & BUSHING: PA46 or FR52, flame retardant, heat stabilized(UL 94V-0).
 PLUNGER: FR52 or PA46 (UL 94V-0), with internal o-ring sealed.
 SURFACE PLATE: Brass (or Phosphor bronze), tin plated.
 TERMINAL SEAL: Epoxy.

Specifications and Dimensions subject to change

If your preferred product configuration is not shown, please contact our sales representative for custom design.

HOW TO ORDER SYSTEM

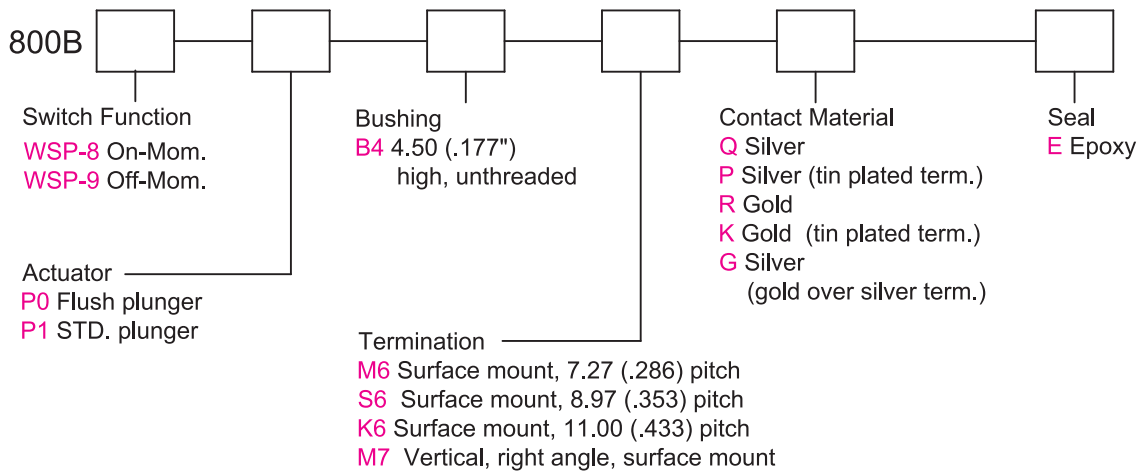

Toggle

Rocker

Slide

Pushbutton

AV

Rotary

Tact

Touch Key

Miscellaneous

M6



Model No.	Type	
	WSP-9	OFF

Schematic



SPST

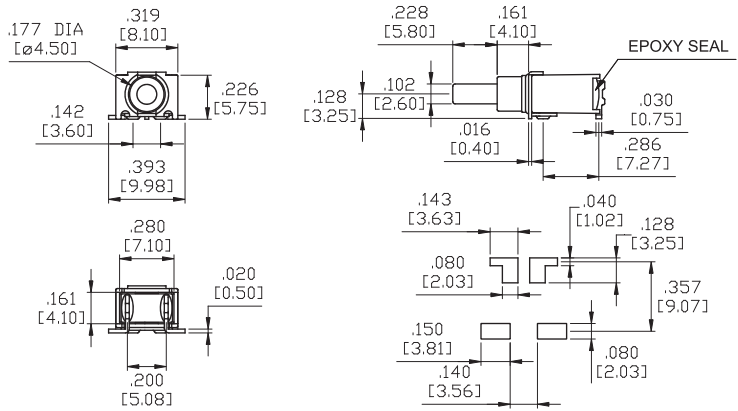

M6



Model No.	Type	
	WSP-8	ON
Term. Comm.	2-1	2-3

Schematic

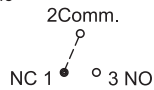

SPDT

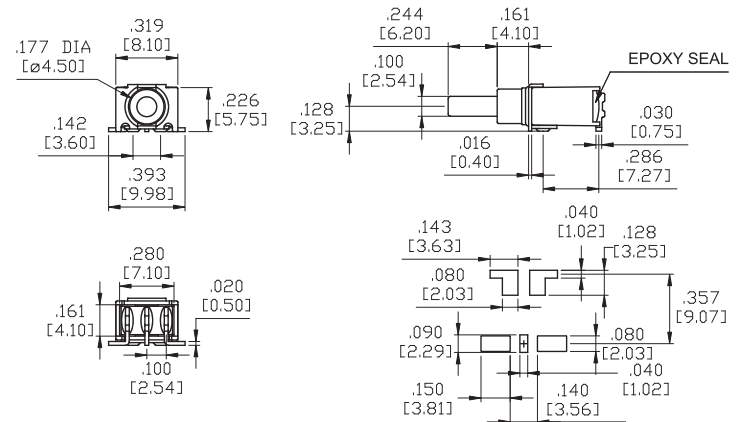

S6



Model No.	Type	
	WSP-9	OFF

Schematic



SPST

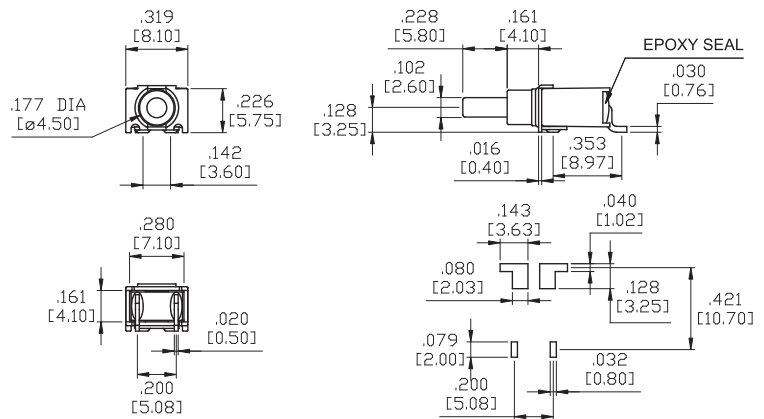

S6



Model No.	Type	
	WSP-8	ON
Term. Comm.	2-1	2-3

Schematic

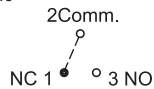

SPDT

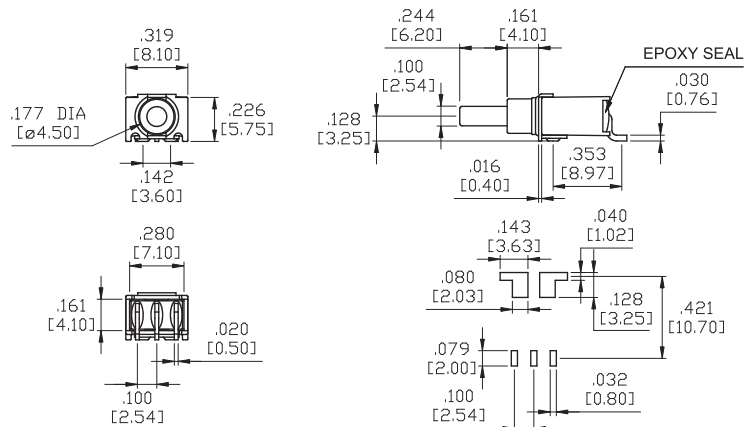

K6



Model No.	Type	
WSP-9	OFF	MOM

Schematic



SPST

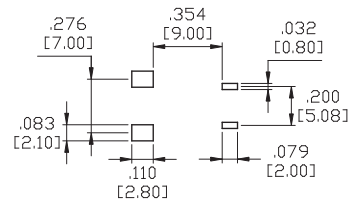
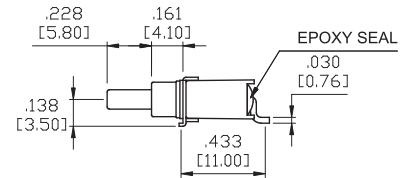
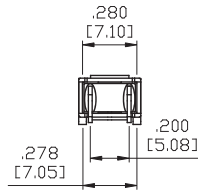
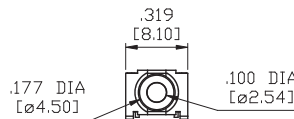

K6



Model No.	Type	
WSP-8	ON	MOM
Term. Comm.	2-1	2-3

Schematic

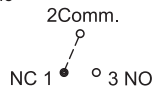

SPDT

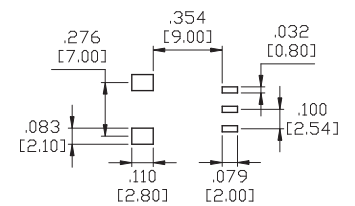
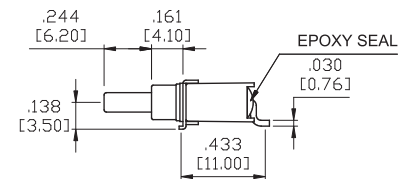
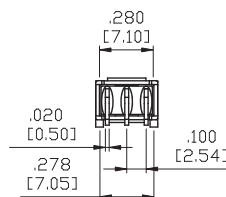
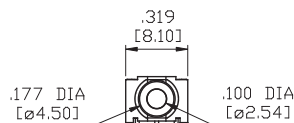

M7



Model No.	Type	
WSP-9	OFF	MOM

Schematic



SPST

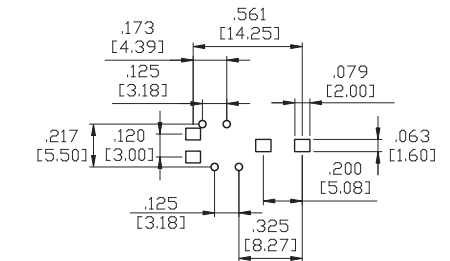
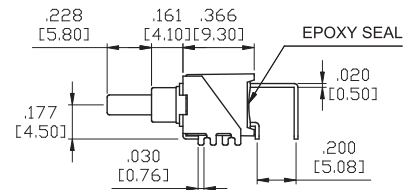
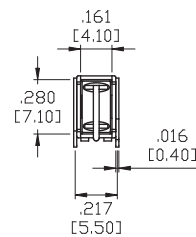
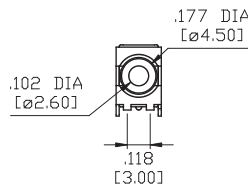

M7



Model No.	Type	
WSP-8	ON	MOM
Term. Comm.	2-1	2-3

Schematic



SPDT

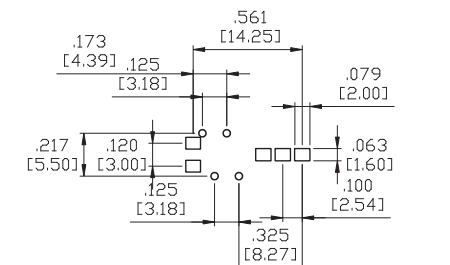
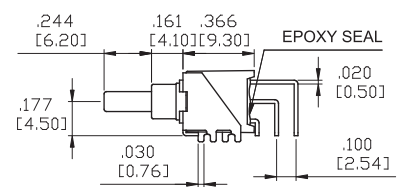
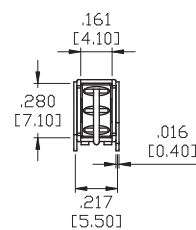
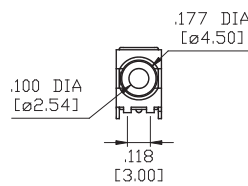

REEL TAPING

FOR M6 ONLY

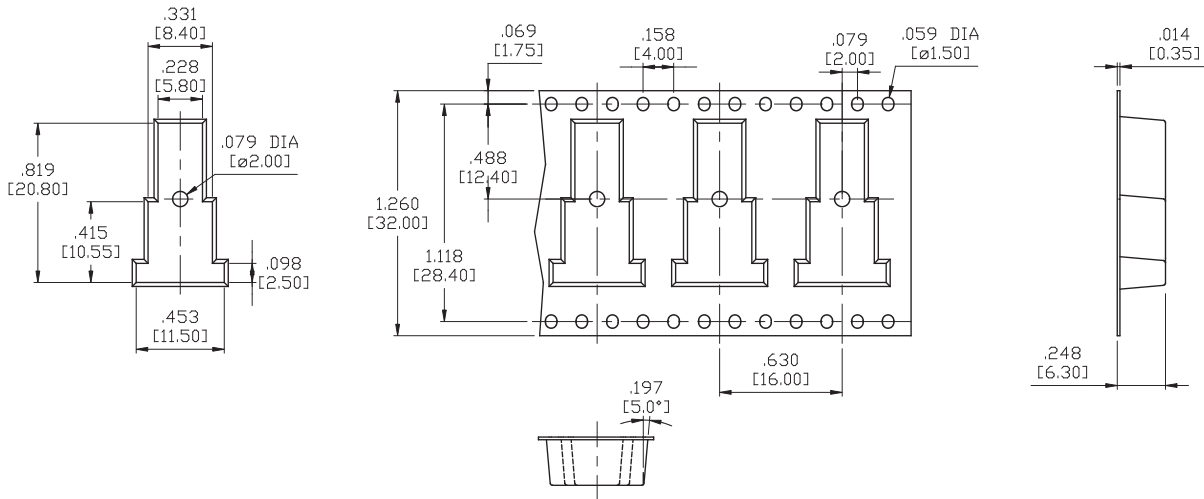

FOR S6 & K6 ONLY

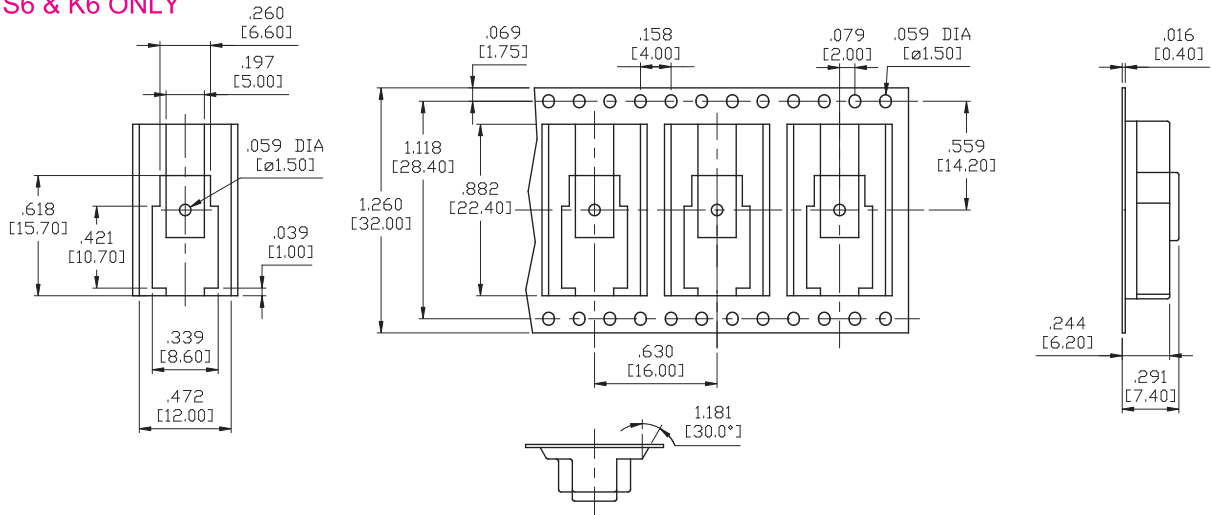

FOR M7 ONLY

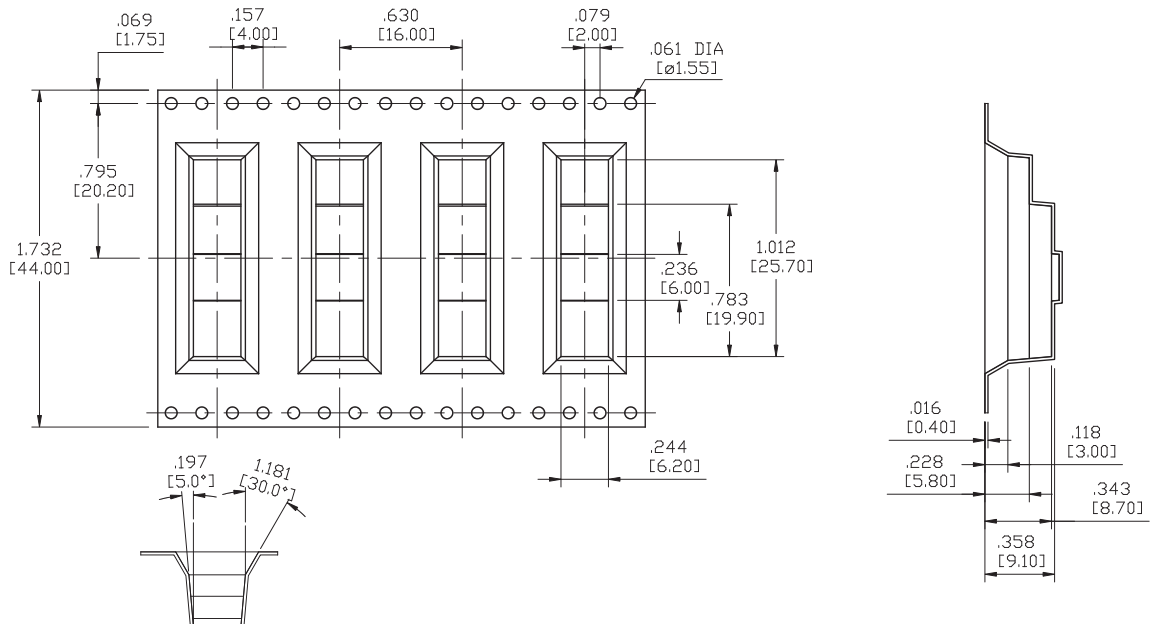

REEL TAPING

REEL INFORMATION	
OUTSIDE DIAMETER	12.99 [330.00]
PILOT HOLE	.502 [13.00]
QUANTITY PER REEL	500 400 (M7 model)

CONTACT MATERIAL OPTIONS

Coding	Contact Material	Terminal Plating	Rating	Agency Approvals
Q	Silver ¹	Silver plated ¹	1Amps @ 125VAC or 28VDC	IP67
P		Tin plated ⁵ / ₇		
R	Gold ²	Gold plated ⁴	0.4VA max @ 20V max (AC or DC)	IP67
K		Tin plated ⁵ / ₆		
G	Silver ¹	Gold over silver ³	1Amps @ 125VAC or 28VDC	IP67

1. Movable Contact / Terminals: Copper alloy, silver plated.
2. Movable Contact: Copper alloy with gold plated over nickel plated.
3. Terminals: Silver plated with outer layer in gold plating.
4. Terminals: Copper alloy, with gold plated over nickel plated.
5. Outer Terminals: Copper alloy with pure tin plated.
6. Terminal Contact: Gold plated over nickel plated.
7. Terminal Contact: Palladium nickel alloy (or Silver) plated.

Toggle

Rocker

Slide

Pushbutton

AV

Rotary

Tact

Touch Key

Miscellaneous