

SPECIFICATIONS:

NON-SWITCHING RATING: 100mA, 50VDC.
 SWITCHING RATING: 25mA, 24VDC.
 CONTACT RESISTANCE: 50mΩ max. initial.
 ELECTRICAL LIFE: 2,000 operations.
 INSULATION RESISTANCE: 500VDC 1minute±1sec. 100MΩ min.
 DIELECTRIC STRENGTH: 500VAC for 1minute.
 OPERATING TEMPERATURE: -20°C to +70°C
 SOLDERING TEMPERATURE: 260°C for 5±1sec.

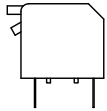
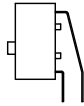
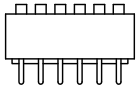

MATERIALS:

COVER: PBT, UL 94V-0, red standard.
 ACTUATOR: PBT, UL 94V-0, white standard.
 TERMINAL: Phosphor bronze, gold plated.
 CONTACT: Phosphor bronze, gold plated.
 BASE: PBT, UL 94V-0, black standard.
 TAPE: Blended silicone and rubber.

Specifications and Dimensions subject to change

DS(R)

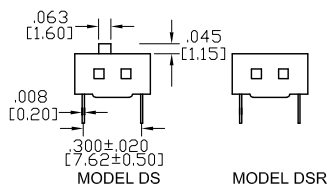
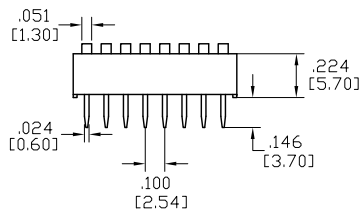
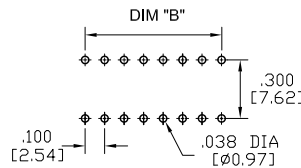
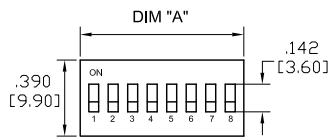
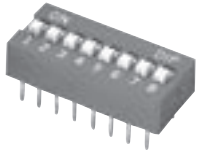

MODEL-POS. NO.	DIM "A"	DIM "B"
DS(R)-02	.239 [6.08]	.100 [2.54]
DS(R)-03	.351 [8.92]	.200 [5.08]
DS(R)-04	.439 [11.16]	.300 [7.62]
DS(R)-05	.539 [13.70]	.400 [10.16]
DS(R)-06	.639 [16.24]	.500 [12.70]
DS(R)-07	.751 [19.08]	.600 [15.24]
DS(R)-08	.839 [21.32]	.700 [17.78]
DS(R)-09	.951 [24.16]	.800 [20.32]
DS(R)-10	1.039 [26.40]	.900 [22.86]
DS(R)-12	1.239 [31.48]	1.100 [27.94]

SCHEMATIC

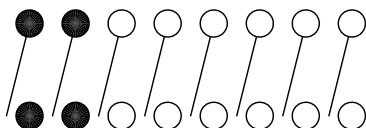

HOW TO ORDER

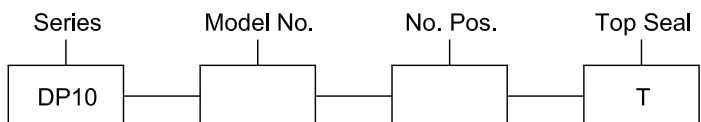

DA

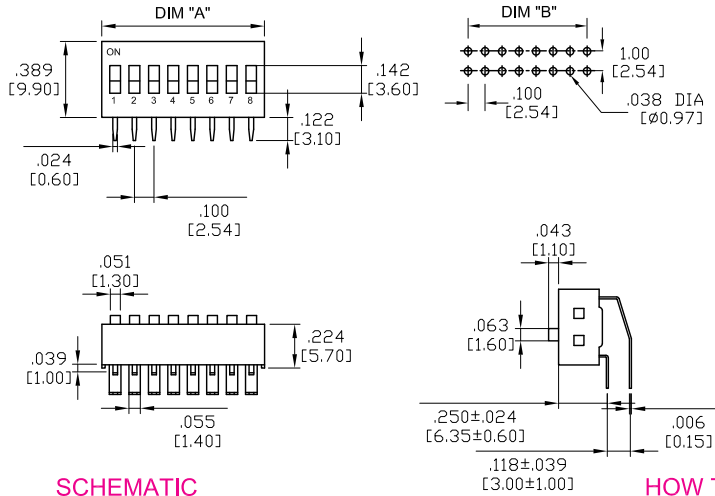
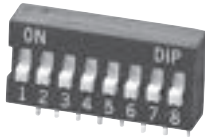

SCHEMATIC

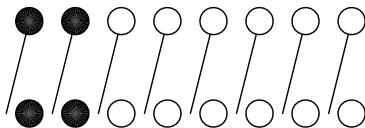

HOW TO ORDER

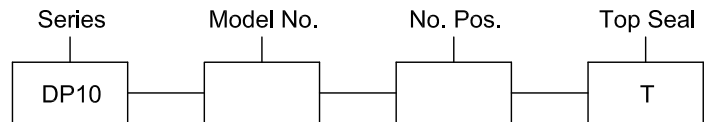

MODEL-POS. NO.	DIM "A"	DIM "B"
DA-02	.239 [6.08]	.100 [2.54]
DA-03	.351 [8.92]	.200 [5.08]
DA-04	.439 [11.16]	.300 [7.62]
DA-05	.539 [13.70]	.400 [10.16]
DA-06	.639 [16.24]	.500 [12.70]
DA-07	.751 [19.08]	.600 [15.24]
DA-08	.839 [21.32]	.700 [17.78]
DA-09	.951 [24.16]	.800 [20.32]
DA-10	1.039 [26.40]	.900 [22.86]
DA-12	1.239 [31.48]	1.100 [27.94]

DP(L)

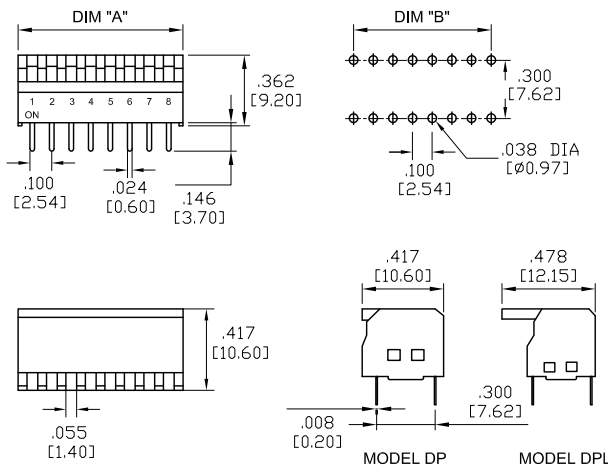
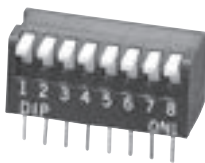

SCHEMATIC

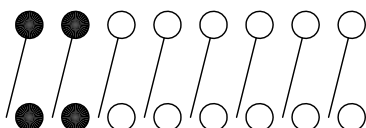

HOW TO ORDER

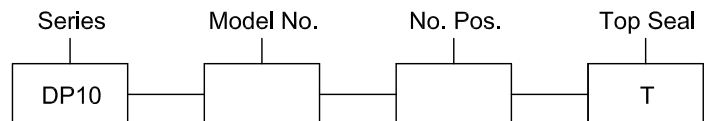

MODEL-POS. NO.	DIM "A"	DIM "B"
DP(L)-02	.246 [6.26]	.100 [2.54]
DP(L)-03	.357 [9.06]	.200 [5.08]
DP(L)-04	.446 [11.34]	.300 [7.62]
DP(L)-05	.546 [13.88]	.400 [10.16]
DP(L)-06	.646 [16.42]	.500 [12.70]
DP(L)-08	.846 [21.50]	.600 [15.24]
DP(L)-10	1.046 [26.58]	.700 [17.78]
DP(L)-12	1.239 [31.48]	.800 [20.32]

Toggle

Rocker

Slide

Pushbutton

AV

Rotary

Tact

Touch Key

Miscellaneous

DPM(R)

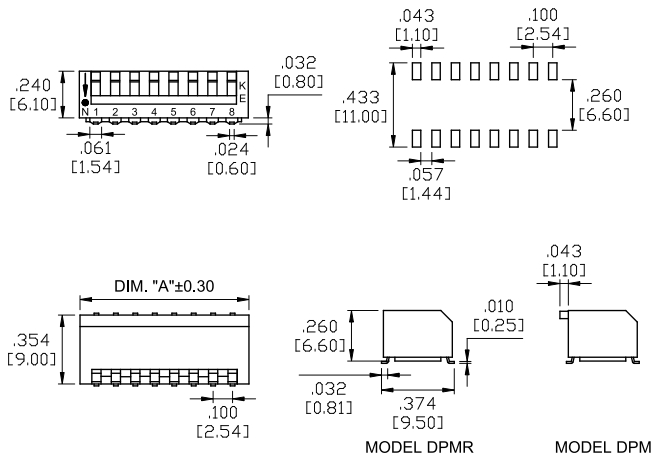

MODEL-POS. NO.	DIM "A"	DIM "B"
DPM(R)-02	.255 [6.48]	.100 [2.54]
DPM(R)-03	.355 [9.02]	.200 [5.08]
DPM(R)-04	.455 [11.56]	.300 [7.62]
DPM(R)-05	.555 [14.10]	.400 [10.16]
DPM(R)-06	.655 [16.64]	.500 [12.70]
DPM(R)-07	.755 [19.18]	.600 [15.24]
DPM(R)-08	.855 [21.72]	.700 [17.78]
DPM(R)-09	.955 [24.26]	.800 [20.32]
DPM(R)-10	1.055 [26.80]	.900 [22.86]
DPM(R)-12	1.255 [31.88]	1.100 [27.94]

SCHEMATIC

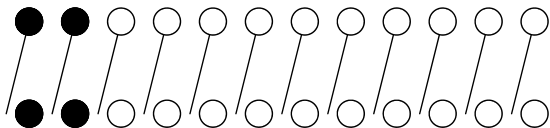

HOW TO ORDER

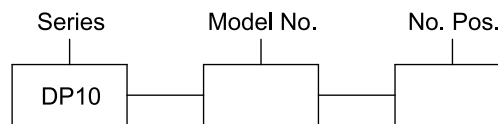

DI(R)

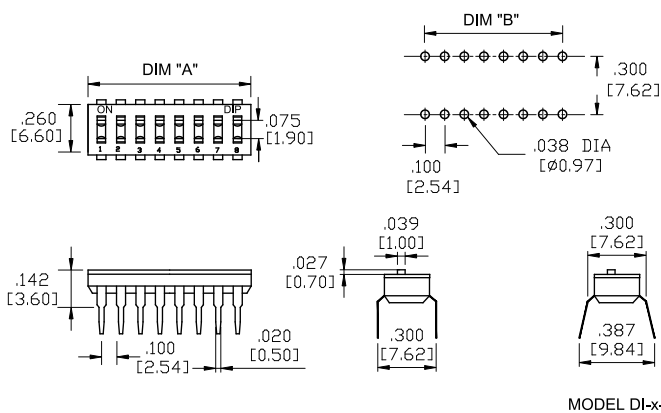
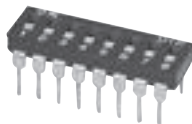

MODEL-POS. NO.	DIM "A"	DIM "B"
DI(R)-01(H)(S)	.137 [3.48]	NONE
DI(R)-02(H)(S)	.237 [6.02]	.100 [2.54]
DI(R)-03(H)(S)	.337 [8.56]	.200 [5.08]
DI(R)-04(H)(S)	.437 [11.10]	.300 [7.62]
DI(R)-05(H)(S)	.537 [13.64]	.400 [10.16]
DI(R)-06(H)(S)	.637 [16.18]	.500 [12.70]
DI(R)-07(H)(S)	.737 [18.72]	.600 [15.24]
DI(R)-08(H)(S)	.837 [21.26]	.700 [17.78]
DI(R)-09(H)(S)	.937 [23.80]	.800 [20.32]
DI(R)-10(H)(S)	1.037 [26.34]	.900 [22.86]
DI(R)-12(H)(S)	1.237 [31.42]	1.100 [27.94]



MODEL DIR-x-H



MODEL DIR-x-S

SCHEMATIC

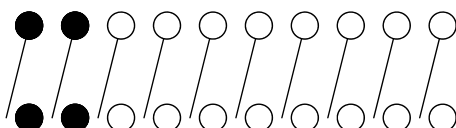

HOW TO ORDER

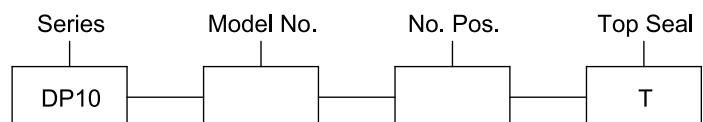

* Top seal is not available for raised actuator

DM(R)

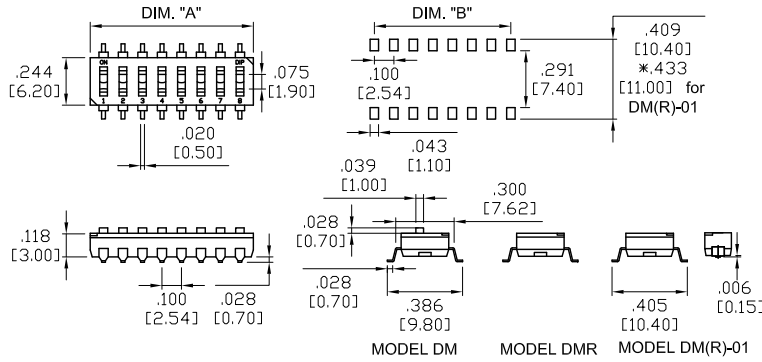

MODEL-POS. NO.	DIM "A"	DIM "B"
DM(R)-01	.137 [3.48]	NONE
DM(R)-02	.237 [6.02]	.100 [2.54]
DM(R)-03	.337 [8.56]	.200 [5.08]
DM(R)-04	.437 [11.10]	.300 [7.62]
DM(R)-05	.537 [13.64]	.400 [10.16]
DM(R)-06	.637 [16.18]	.500 [12.70]
DM(R)-07	.737 [18.72]	.600 [15.24]
DM(R)-08	.837 [21.26]	.700 [17.78]
DM(R)-09	.937 [23.80]	.800 [20.32]
DM(R)-10	1.037 [26.34]	.900 [22.86]
DM(R)-12	1.237 [31.42]	1.100 [27.94]

SCHEMATIC

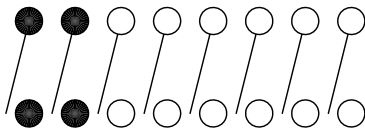

HOW TO ORDER

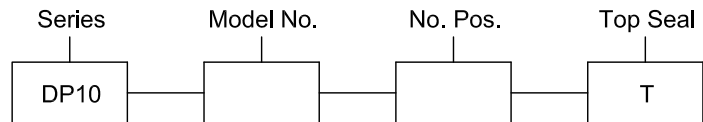

* Top seal is not available for raised actuator

DH

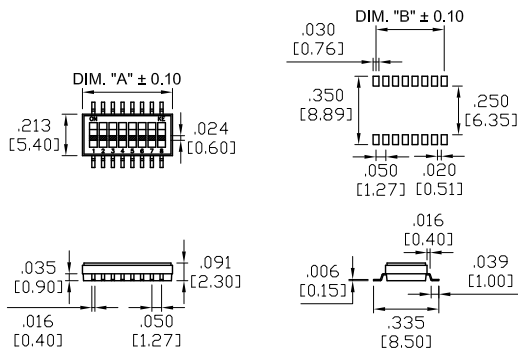

MODEL-POS. NO.	DIM "A"	DIM "B"
DH-02	.162 [4.12]	.050 [1.27]
DH-04	.262 [6.66]	.150 [3.81]
DH-06	.362 [9.20]	.250 [6.35]
DH-08	.462 [11.74]	.350 [8.89]
DH-10	.562 [14.28]	.450 [11.43]

SCHEMATIC

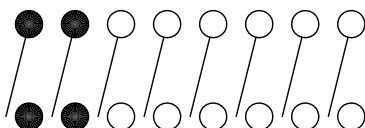

HOW TO ORDER

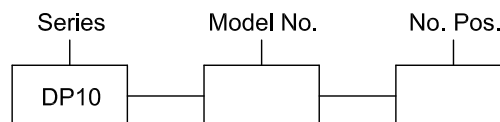

* "Blank" - with top seal ; "N" - Without top sea

Toggle

Rocker

Slide

Pushbutton

AV

Rotary

Tact

Touch Key

Miscellaneous